

ZXMS6002G

60V N-Channel self protected enhancement mode IntelliFET™ MOSFET with status indication

Summary

Continuous drain source voltage	$V_{DS} = 60V$
On-state resistance	500mΩ
Nominal load current ($V_{IN} = 5V$)	1.4A
Clamping energy	550mJ

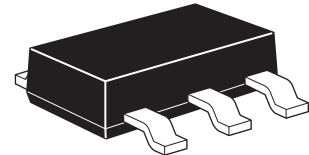

Description

Self protected low side MOSFET. Monolithic over temperature, over current, over voltage (active clamp) and ESD protected logic level functionality. Intended as a general purpose switch, with status indication.

Features

- Status pin (analog status indication)
- Short circuit protection with auto restart
- Over voltage protection (active clamp)
- Thermal shutdown with auto restart
- Over-current protection
- Input protection (ESD)
- Load dump protection (actively protects load)
- Logic level input
- High continuous current rating

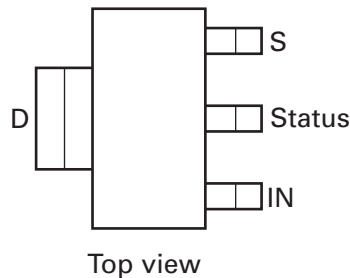

Note: The tab is connected to the drain pin and must be electrically isolated from the source pin. Connection of significant copper to the tab is recommended for best thermal performance.

Ordering information

Device	Part mark	Reel size (inches)	Tape width (mm)	Quantity per reel
ZXMS6002GTA	ZXMS6002	7	12 embossed	1000

Functional block diagram

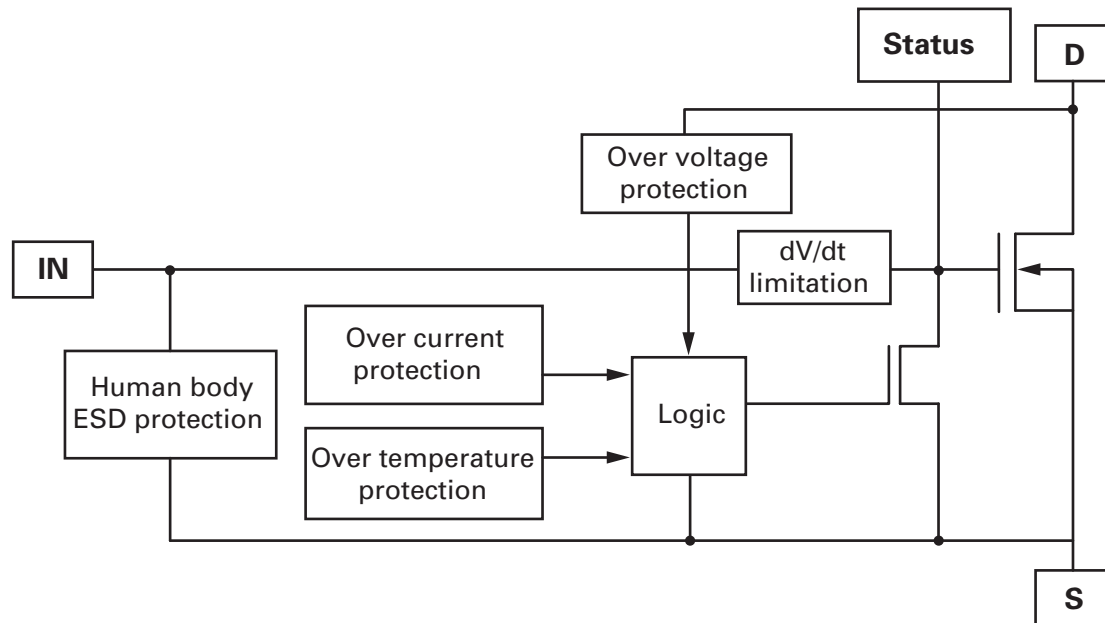

Applications and information

- Especially suited for loads with a high in-rush current such as lamps and motors
- All types of resistive, inductive and capacitive loads in switching applications
- μC compatible power switch for 12V and 24V DC applications
- Automotive rated
- Replaces electromechanical relays and discrete circuits
- Linear mode capability - the current-limiting protection circuitry is designed to de-activate at low V_{DS} , in order not to compromise the load current during normal operation. The design max. DC operating current is therefore determined by the thermal capability of the package/board combination, rather than by the protection circuitry
Note: This does not compromise the product's ability to self-protect during short-circuit load conditions.
- Status pin voltage reflects the gate drive being applied internally to the power MOSFET.
With $V_{\text{IN}} = 5\text{V}$:
Status voltage $\sim 5\text{V}$ indicates normal operation.
Status voltage $\sim (2-3)\text{V}$ indicates that the device is in current-limiting mode.
Status voltage $< 1\text{V}$ indicates that the device is in thermal shutdown.

Current Limiting and Over Temp Shutdown Status Indication at Vin=5V

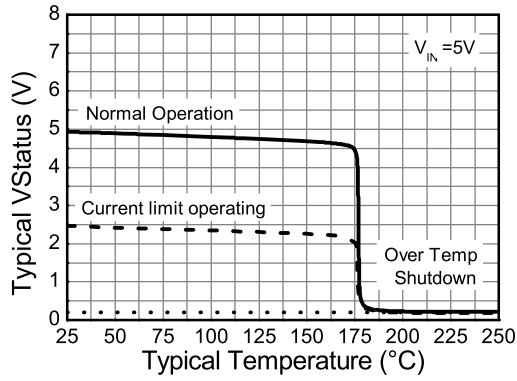

Current Limiting and Over Temp Shutdown Status Indication at Vin=10V

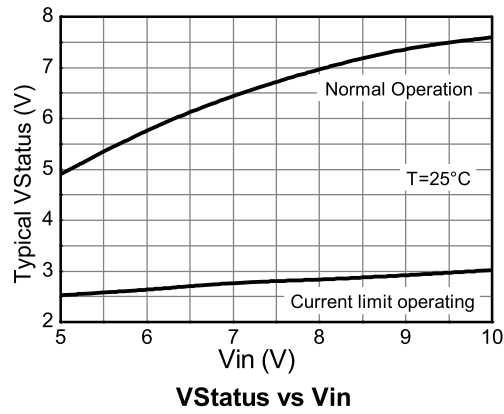
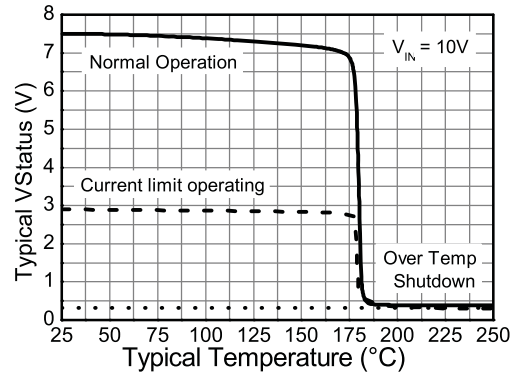

Absolute maximum ratings

Parameter	Symbol	Limit	Unit
Continuous drain-source voltage	V_{DS}	60	V
Drain-source voltage for short circuit protection $V_{IN}=5V$	$V_{DS(SC)}$	36	V
Drain-source voltage for short circuit protection $V_{IN}=10V$	$V_{DS(SC)}$	20	V
Continuous input voltage	V_{IN}	-0.2 ... +10	V
Peak input voltage	V_{IN}	-0.2 ... +20	V
Operating temperature range	T_j	-40 to +150	°C
Storage temperature range	T_{stg}	-55 to +150	°C
Power dissipation @ $T_{amb}=25^{\circ}C^{(a)}$	P_D	2.5	W
Continuous drain current @ $V_{IN}=10V$; $T_{amb}=25^{\circ}C^{(a)}$	I_D	1.6	A
Continuous drain current @ $V_{IN}=5V$; $T_{amb}=25^{\circ}C^{(a)}$	I_D	1.4	A
Continuous source current (body diode) ^(a)	I_S	3	A
Pulsed source current (body diode) ^(b)	I_S	4.7	A
Unclamped single pulse inductive energy	E_{AS}	550	mJ
Load dump protection	$V_{LoadDump}$	80	V
Electrostatic discharge (human body model)	V_{ESD}	4000	V
DIN humidity category, DIN 40 040		E	
IEC climatic category, DIN IEC 68-1		40/150/56	

Thermal resistance

Parameter	Symbol	Limit	Unit
Junction to ambient ^(a)	$R_{\theta JA}$	50	°C/W
Junction to ambient ^(b)	$R_{\theta JA}$	28	°C/W

NOTES:

(a) For a device surface mounted on 50mm x 50mm x 1.6mm FR4 board with a high coverage of single sided 2oz weight copper.

(b) For a device surface mounted on FR4 board as (a) and measured at $t \leq 10s$.

Characteristics

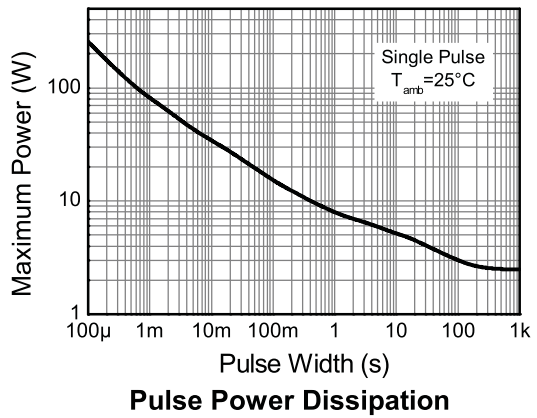
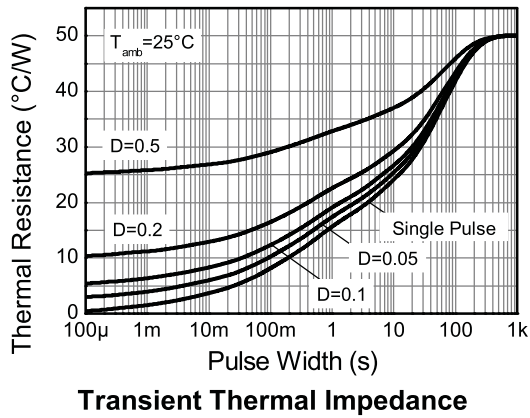
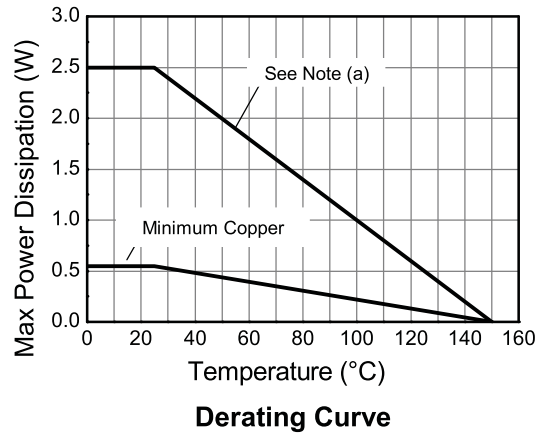
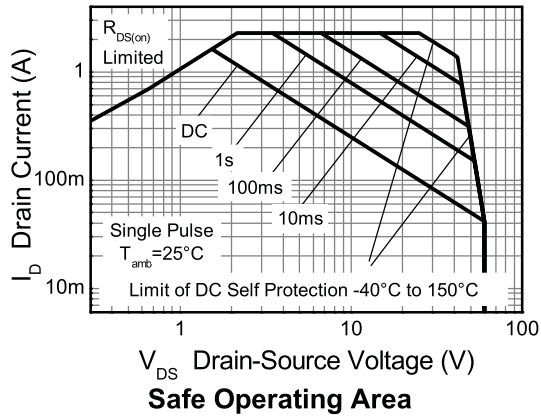

ZXMS6002G

Electrical characteristics (at $T_{amb} = 25^{\circ}\text{C}$ unless otherwise stated)

Parameter	Symbol	Min.	Typ.	Max.	Unit	Conditions
Static characteristics						
Drain-source clamp voltage	$V_{DS(AZ)}$	60	70	75	V	$I_D=10\text{mA}$
Off state drain current	I_{DSS}		0.1	3	μA	$V_{DS}=12\text{V}, V_{IN}=0\text{V}$
Off state drain current	I_{DSS}		3	15	μA	$V_{DS}=32\text{V}, V_{IN}=0\text{V}$
Input threshold voltage (*)	$V_{IN(th)}$	1	2.1		V	$V_{DS}=V_{GS}, I_D=1\text{mA}$
Input current	I_{IN}		0.7	1.2	mA	$V_{IN}=+5\text{V}$
Input current	I_{IN}		1.5	2.7	mA	$V_{IN}=+7\text{V}$
Input current	I_{IN}		4	7	mA	$V_{IN}=+10\text{V}$
Static drain-source on-state resistance	$R_{DS(on)}$		520	675	$\text{m}\Omega$	$V_{IN}=5\text{V}, I_D=0.7\text{A}$
Static drain-source on-state resistance	$R_{DS(on)}$		385	500	$\text{m}\Omega$	$V_{IN}=10\text{V}, I_D=0.7\text{A}$
Current limit (†)	$I_{D(LIM)}$	0.7	1.0	1.5	A	$V_{IN}=5\text{V}, V_{DS}>5\text{V}$
Current limit (†)	$I_{D(LIM)}$	1.0	1.8	2.3	A	$V_{IN}=10\text{V}, V_{DS}>5\text{V}$
Dynamic characteristics						
Turn-off time (V_{IN} to 90% I_D)	t_{off}		13	20	μs	$R_L=22\Omega, V_{IN}=10\text{V}$ to $0\text{V}, V_{DD}=12\text{V}$
Slew rate on (70 to 50% V_{DD})	$-dV_{DS}/dt_{on}$		8	20	$\text{V}/\mu\text{s}$	$R_L=22\Omega, V_{IN}=0$ to $10\text{V}, V_{DD}=12\text{V}$
Slew rate off (50 to 70% V_{DD})	dV_{DS}/dt_{on}		3.2	10	$\text{V}/\mu\text{s}$	$R_L=22\Omega, V_{IN}=10\text{V}$ to $0\text{V}, V_{DD}=12\text{V}$
Protection functions (‡)						
Required input voltage for over temperature protection	V_{PROT}	4.5			V	
Thermal overload trip temperature	T_{JT}	150	175		$^{\circ}\text{C}$	
Thermal hysteresis			1		$^{\circ}\text{C}$	
Unclamped single pulse inductive energy $T_j=25^{\circ}\text{C}$	E_{AS}	550			mJ	$I_{D(ISO)}=0.7\text{A}, V_{DD}=32\text{V}$
Unclamped single pulse inductive energy $T_j=150^{\circ}\text{C}$	E_{AS}	200			mJ	$I_{D(ISO)}=0.7\text{A}, V_{DD}=32\text{V}$

ZXMS6002G

Electrical characteristics (at $T_{amb} = 25^{\circ}\text{C}$ unless otherwise stated)

Parameter	Symbol	Min.	Typ.	Max.	Unit	Conditions
Status flag						
Normal operation	V_{STATUS}		4.95		V	$V_{IN} = 5\text{V}$
Current limit operating	V_{STATUS}		2.5		V	$V_{IN} = 5\text{V}$
Thermal shutdown activated	V_{STATUS}		0.2	1	V	$V_{IN} = 5\text{V}$
Normal operation	V_{STATUS}		8.0		V	$V_{IN} = 10\text{V}$
Current limit operation	V_{STATUS}		3.0		V	$V_{IN} = 10\text{V}$
Thermal shutdown activated	V_{STATUS}		0.35	1	V	$V_{IN} = 10\text{V}$
Inverse diode						
Source drain voltage	V_{SD}			1	V	$V_{IN}=0\text{V}, -I_D=1.4\text{A},$

NOTES:

(*) Protection features may operate outside spec for $V_{IN}<4.5\text{V}$.

(†) The drain current is limited to a reduced value when V_{ds} exceeds a safe level

(‡) Integrated protection functions are designed to prevent IC destruction under fault conditions described in the datasheet. Fault conditions are considered as "outside" normal operating range. Protection functions are not designed for continuous, repetitive operation.

Typical characteristics

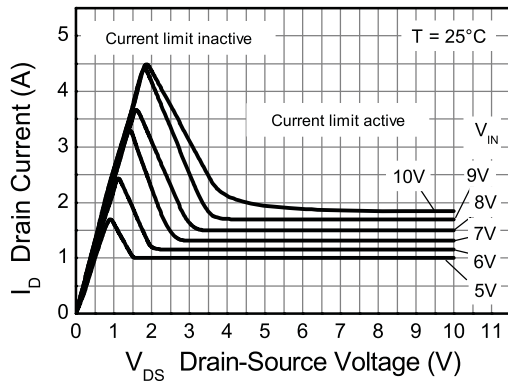

Typical Output Characteristic

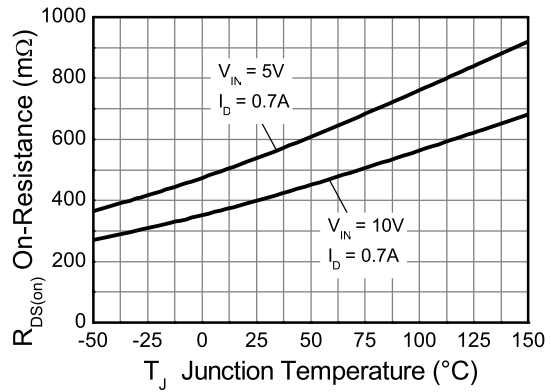

On-state Resistance vs Temperature

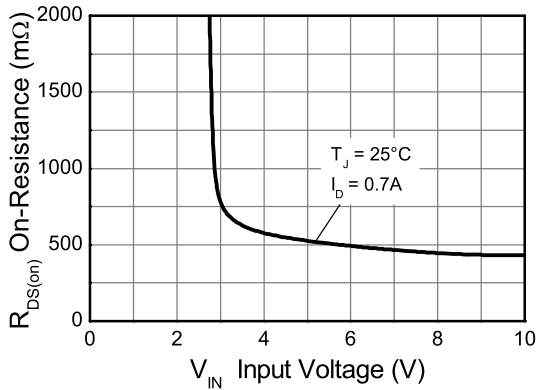

On-Resistance vs Input Voltage

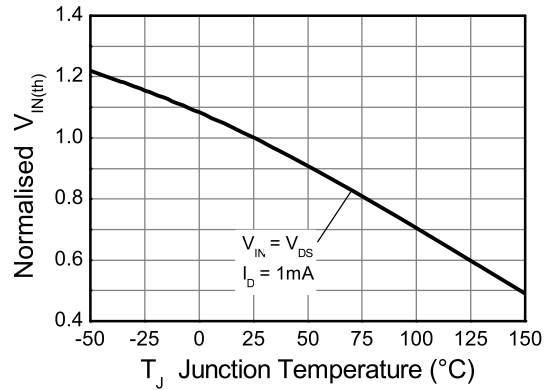

Threshold Voltage vs Temperature

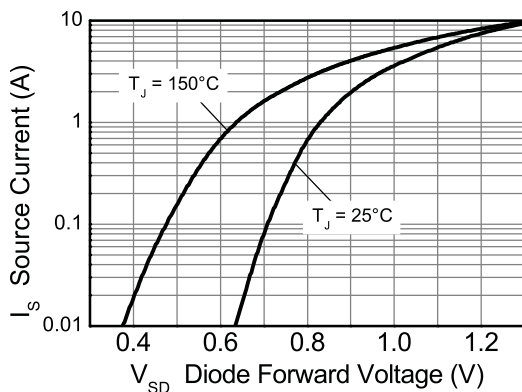

Source-Drain Diode Forward Voltage

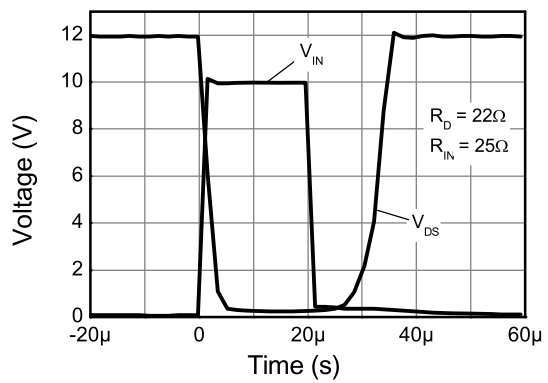

Switching Speed

ZXMS6002G

Package outline - SOT223

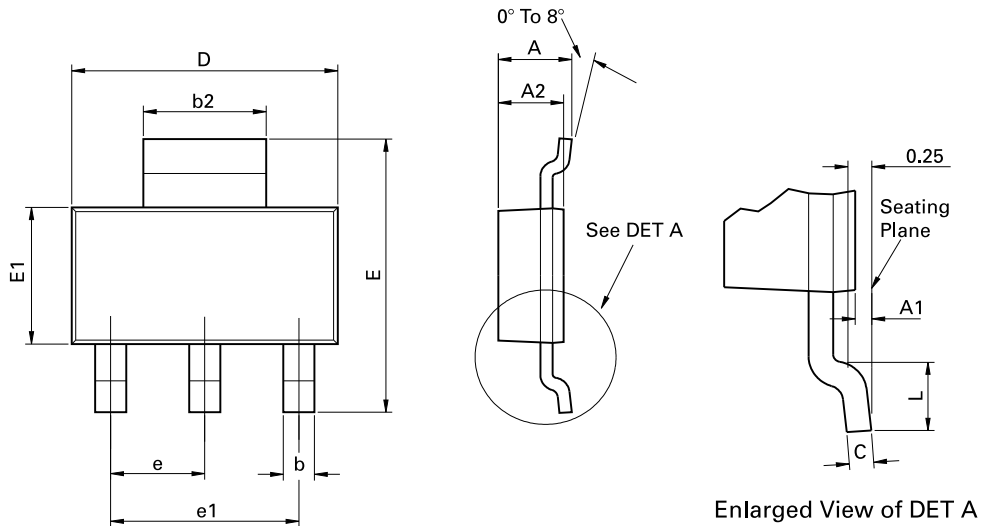

Conforms to JEDEC TO-261 AA Issue B

DIM	Millimeters		Inches		DIM	Millimeters		Inches	
	Min	Max	Min	Max		Min	Max	Min	Max
A	-	1.80	-	0.071	e	2.30 BSC		0.0905 BSC	
A1	0.02	0.10	0.0008	0.004	e1	4.60 BSC		0.181 BSC	
b	0.66	0.84	0.026	0.033	E	6.70	7.30	0.264	0.287
b2	2.90	3.10	0.114	0.122	E1	3.30	3.70	0.130	0.146
C	0.23	0.33	0.009	0.013	L	0.90	-	0.355	-
D	6.30	6.70	0.248	0.264	-	-	-	-	-

Note: Controlling dimensions are in millimeters. Approximate dimensions are provided in inches

Definitions

Product change

Zetex Semiconductors reserves the right to alter, without notice, specifications, design, price or conditions of supply of any product or service. Customers are solely responsible for obtaining the latest relevant information before placing orders.

Applications disclaimer

The circuits in this design/application note are offered as design ideas. It is the responsibility of the user to ensure that the circuit is fit for the user's application and meets with the user's requirements. No representation or warranty is given and no liability whatsoever is assumed by Zetex with respect to the accuracy or use of such information, or infringement of patents or other intellectual property rights arising from such use or otherwise. Zetex does not assume any legal responsibility or will not be held legally liable (whether in contract, tort (including negligence), breach of statutory duty, restriction or otherwise) for any damages, loss of profit, business, contract, opportunity or consequential loss in the use of these circuit applications, under any circumstances.

Life support

Zetex products are specifically not authorized for use as critical components in life support devices or systems without the express written approval of the Chief Executive Officer of Zetex Semiconductors plc. As used herein:

A. Life support devices or systems are devices or systems which:

1. are intended to implant into the body

or

2. support or sustain life and whose failure to perform when properly used in accordance with instructions for use provided in the labelling can be reasonably expected to result in significant injury to the user.

B. A critical component is any component in a life support device or system whose failure to perform can be reasonably expected to cause the failure of the life support device or to affect its safety or effectiveness.

Reproduction

The product specifications contained in this publication are issued to provide outline information only which (unless agreed by the company in writing) may not be used, applied or reproduced for any purpose or form part of any order or contract or be regarded as a representation relating to the products or services concerned.

Terms and Conditions

All products are sold subjects to Zetex' terms and conditions of sale, and this disclaimer (save in the event of a conflict between the two when the terms of the contract shall prevail) according to region, supplied at the time of order acknowledgement.

For the latest information on technology, delivery terms and conditions and prices, please contact your nearest Zetex sales office.

Quality of product

Zetex is an ISO 9001 and TS16949 certified semiconductor manufacturer.

To ensure quality of service and products we strongly advise the purchase of parts directly from Zetex Semiconductors or one of our regionally authorized distributors. For a complete listing of authorized distributors please visit: www.zetex.com/salesnetwork

Zetex Semiconductors does not warrant or accept any liability whatsoever in respect of any parts purchased through unauthorized sales channels.

ESD (Electrostatic discharge)

Semiconductor devices are susceptible to damage by ESD. Suitable precautions should be taken when handling and transporting devices. The possible damage to devices depends on the circumstances of the handling and transporting, and the nature of the device. The extent of damage can vary from immediate functional or parametric malfunction to degradation of function or performance in use over time. Devices suspected of being affected should be replaced.

Green compliance

Zetex Semiconductors is committed to environmental excellence in all aspects of its operations which includes meeting or exceeding regulatory requirements with respect to the use of hazardous substances. Numerous successful programs have been implemented to reduce the use of hazardous substances and/or emissions.

All Zetex components are compliant with the RoHS directive, and through this it is supporting its customers in their compliance with WEEE and ELV directives.

Product status key:

"Preview"	Future device intended for production at some point. Samples may be available
"Active"	Product status recommended for new designs
"Last time buy (LTB)"	Device will be discontinued and last time buy period and delivery is in effect
"Not recommended for new designs"	Device is still in production to support existing designs and production
"Obsolete"	Production has been discontinued

Datasheet status key:

"Draft version"	This term denotes a very early datasheet version and contains highly provisional information, which may change in any manner without notice.
"Provisional version"	This term denotes a pre-release datasheet. It provides a clear indication of anticipated performance. However, changes to the test conditions and specifications may occur, at any time and without notice.
"Issue"	This term denotes an issued datasheet containing finalized specifications. However, changes to specifications may occur, at any time and without notice.

Zetex sales offices

Europe	Americas	Asia Pacific	Corporate Headquarters
Zetex GmbH Kustermann-park Balanstraße 59 D-81541 München Germany Telephone: (49) 89 45 49 49 0 Fax: (49) 89 45 49 49 49 europe.sales@zetex.com	Zetex Inc 700 Veterans Memorial Highway Hauppauge, NY 11788 USA Telephone: (1) 631 360 2222 Fax: (1) 631 360 8222 usa.sales@zetex.com	Zetex (Asia Ltd) 3701-04 Metroplaza Tower 1 Hing Fong Road, Kwai Fong Hong Kong Telephone: (852) 26100 611 Fax: (852) 24250 494 asia.sales@zetex.com	Zetex Semiconductors plc Zetex Technology Park, Chadderton Oldham, OL9 9LL United Kingdom Telephone: (44) 161 622 4444 Fax: (44) 161 622 4446 hq@zetex.com

© 2007 Published by Zetex Semiconductors plc